

**Qimia**  
MACHINE INTELLIGENCE

qimia.io





## Overview



### Who we are

We are a growing international IT Company, with +80 permanent software engineers and Developers.



### What we do

At Qimia we develop next-generation technologies that provide new, and effective, ways to interact, explore and interpret data. The amalgam of our success comes from a mixture of cutting-edge technologies such as Big Data, Software Development, Machine Learning and Cloud Technologies, and our roster of permanent experts.

**5 hubs across 3 continents**, and more than 15 years of IT project experience, allow our team of more than 120 experts to provide the most effective solutions to our clientele. Our diversified expertise in mobile and software development, creates the perfect environment for your business's success.

SAN FRANCISCO

HANNOVER

COLOGNE

5 Offices

3 Continents

SAN DIEGO

ISTANBUL



## AI and Data Science

- Machine Learning
- Deep Learning
- MLOps
- ML Systems
- Data Visualization
- Data Analysis



## Big Data / Data Warehousing Systems

- Data Lake
- Data Warehouse
- Data Mart
- Data Analytics
- Business Intelligence



## Cloud Development

- AWS
- Google
- Azure
- DevOps
- Cloud Native App Development
- Cloud Migration
- Cloud Architecture

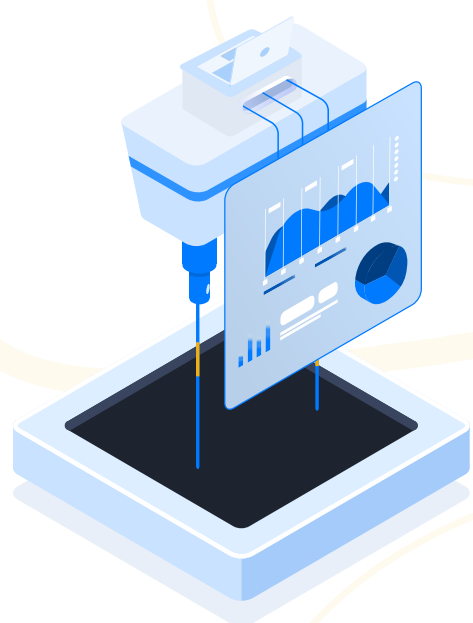

## Data Engineering

- ETL / ELT
- Data Migration
- Data Analytics



## Web Development

- Front-End Development
- Back-End Development
- Full-Stack Development
- API Development



## Mobile Development

- iOS
- Android
- Cross-Platform

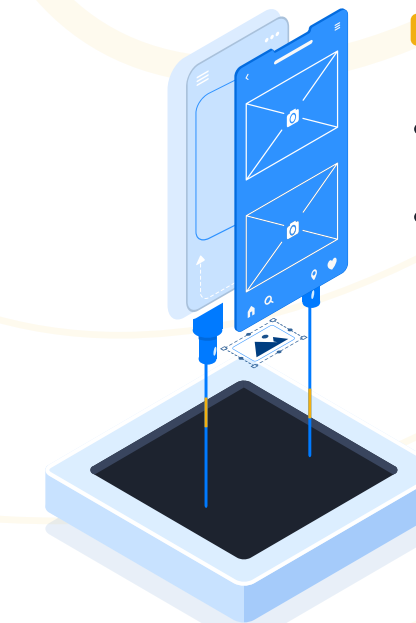

## Product Design

- User Experience Design
- User Interface Design

Artificial Intelligence and Data Science

# A New Age of Technology!

Our cutting-edge technologies allow us to interpret data precisely through many iterations utilizing latest techniques in Artificial Intelligence.

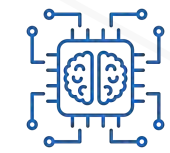

Machine Learning

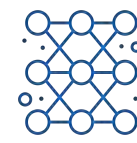

Deep Learning

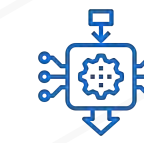

MLOps



ML Systems



Data Visualization



Data Analysis

## Trusted by the World's Leading Companies

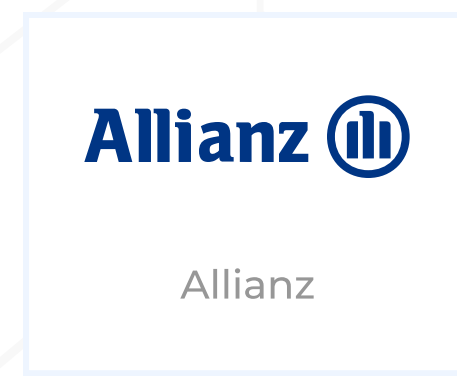
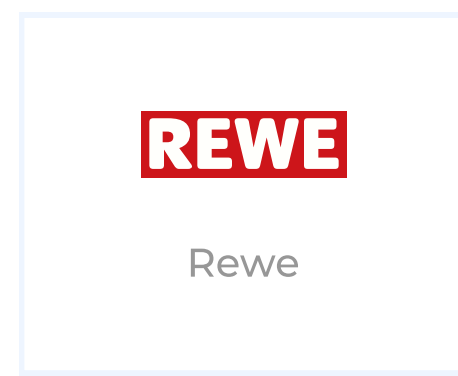

- Artificial Intelligence and Data Science
- Big Data / Data Warehousing Systems**
- Cloud Development
- Data Engineering
- Web Development
- Mobile Development
- Product Design

# Everything falls into the Correct Space!

Our multitude of techniques that encompass different techniques, allow us to interpret, categorize and sort all of your business's data, making it easily understandable for the end-user.



## Trusted by the World's Leading Companies



- Artificial Intelligence and Data Science
- Big Data / Data Warehousing Systems
- Cloud Development**
- Data Engineering
- Web Development
- Mobile Development
- Product Design

# Endless Data at your Fingertips!

Data of any volume, variety or velocity stored through Cloud Storage and Migration tools, and processed via Cloud Native frameworks such as Spark, giving you access on your requested devices.

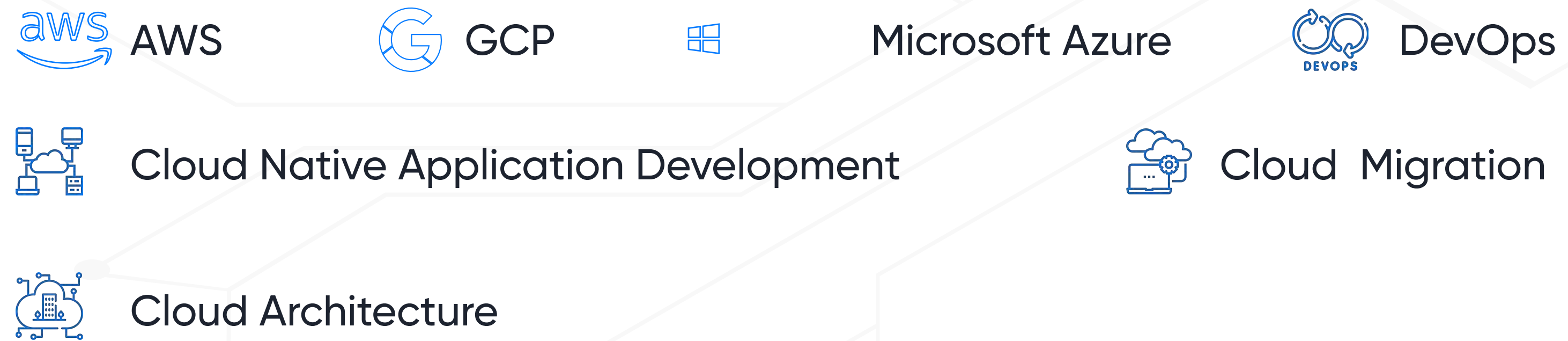

## Trusted by the World's Leading Companies



- Artificial Intelligence and Data Science
- Big Data / Data Warehousing Systems
- Cloud Development
- Data Engineering**
- Web Development
- Mobile Development
- Product Design

# Creating the Perfect Pipelines!

Collect, Store and Analyse Data of any volume through customized systems, giving your business the data-driven edge to stand out from the crowd

 **ETL/ELT**

 **Data Migration**

 **Data Analytics**

## Trusted by the World's Leading Companies

  
Merck

  
BMW

  
Lufthansa

  
NORD/LB

- Artificial Intelligence and Data Science
- Big Data / Data Warehousing Systems
- Cloud Development
- Data Engineering
- Web Development**
- Mobile Development
- Product Design

## Making brands global!

Professionals and state-of-the-art technologies at your disposal to create a digital platform that will get traffic and create leads.



Front-End Development



Back-End Development



Full-Stack Development



API Development

### Trusted by the World's Leading Companies

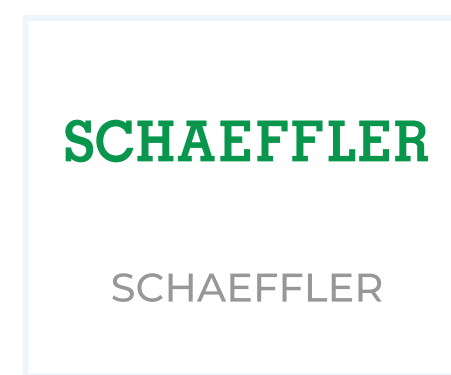



- Artificial Intelligence and Data Science
- Big Data / Data Warehousing Systems
- Cloud Development
- Data Engineering
- Web Development
- Mobile Development**
- Product Design

## Products on all Systems!

On all desired mobile OSs', i.e., Android and iOS, achieve a truly unique and seamless experience through professionally structured immersive applications.



**Trusted by the World's Leading Companies**



- Artificial Intelligence and Data Science
- Big Data / Data Warehousing Systems
- Cloud Development
- Data Engineering
- Web Development
- Mobile Development

**Product Design**

# Representing your Brand!

Creating a visual representation of your brand that can withstand the test of time, in both the physical and digital realm using state-of-the-art technologies. End-to-end Processes adjusted to your business



User Experience Design



User Interface Design

## Trusted by the World's Leading Companies

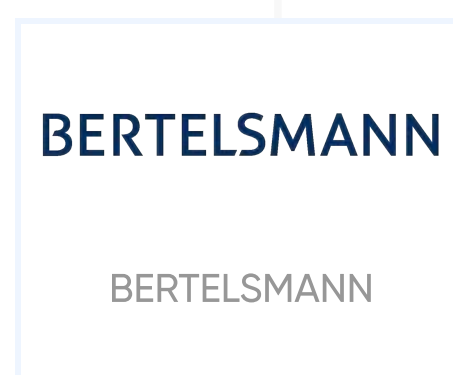



## Motto

Innovative IT Service provider that leverages state-of-the-art technology to give your business the competitive edge

### Services extending from compact data science applications to large-scale end-to-end solutions

The service portfolio of Qimia GmbH includes the following areas: Data Science & AI, Data Engineering, Big Data, DevOps, Web/App Development and Cloud Development.

### On-demand access to an extensive talent pool and unlimited resources.

Qimia has resourced major projects at short notice. In addition to our permanent pool of experts with over thousands of CVs, we have new staff with different skills that can be recruited, trained and deployed promptly. Our team can therefore also be deployed for ad-hoc work packages.

### State-of-the-art IT-solutions tailor-made for your business

We do not offer a ready-made product portfolio or end product. We conduct a detailed needs analysis to offer cost-effective and customised solutions.

### Dedicated to developing effective business solutions for clients

Well-known DAX-listed groups have been benefiting from our services for numerous years and have taken their operations to the next level with our business solutions.

### Flexible consultancy service, on-site or remote by request

Our experts are available to you both remotely and on-site.

### Streamlined workflows with Certified Scrum Masters and a deep-rooted Agile mentality

Our approach to quality is to create value as swiftly and steadily as possible. We work with Agile methods, with the help of which we create increments after each iteration that deliver real value. All employees are committed to this mentality.

### Certified IT professionals with impeccable credentials

Our team of certified IT experts boasts a track record of successful projects and notable client references, demonstrating our proficiency in delivering high-quality solutions.

### An adaptable and comprehensive tech stack for all your business' needs

The Qimia tech stack comprises a wide range of technologies and tools that make it possible to optimise business processes, increase productivity and enhance flexibility.

### Full-time employment only, so no outside contractors or freelancers

At Qimia, we place great emphasis on the quality of our work. In order to be able to guarantee this quality, we only work with permanent employees who have undergone an intensive training programme beforehand. Only after this phase is completed do our experts come to work with you.

### IT service provider for industry-leading companies, with +15 years of project experience

Qimia is an experienced IT service provider specialising in supporting and advising companies from a wide range of industries in optimising their business processes and implementing innovative technologies.

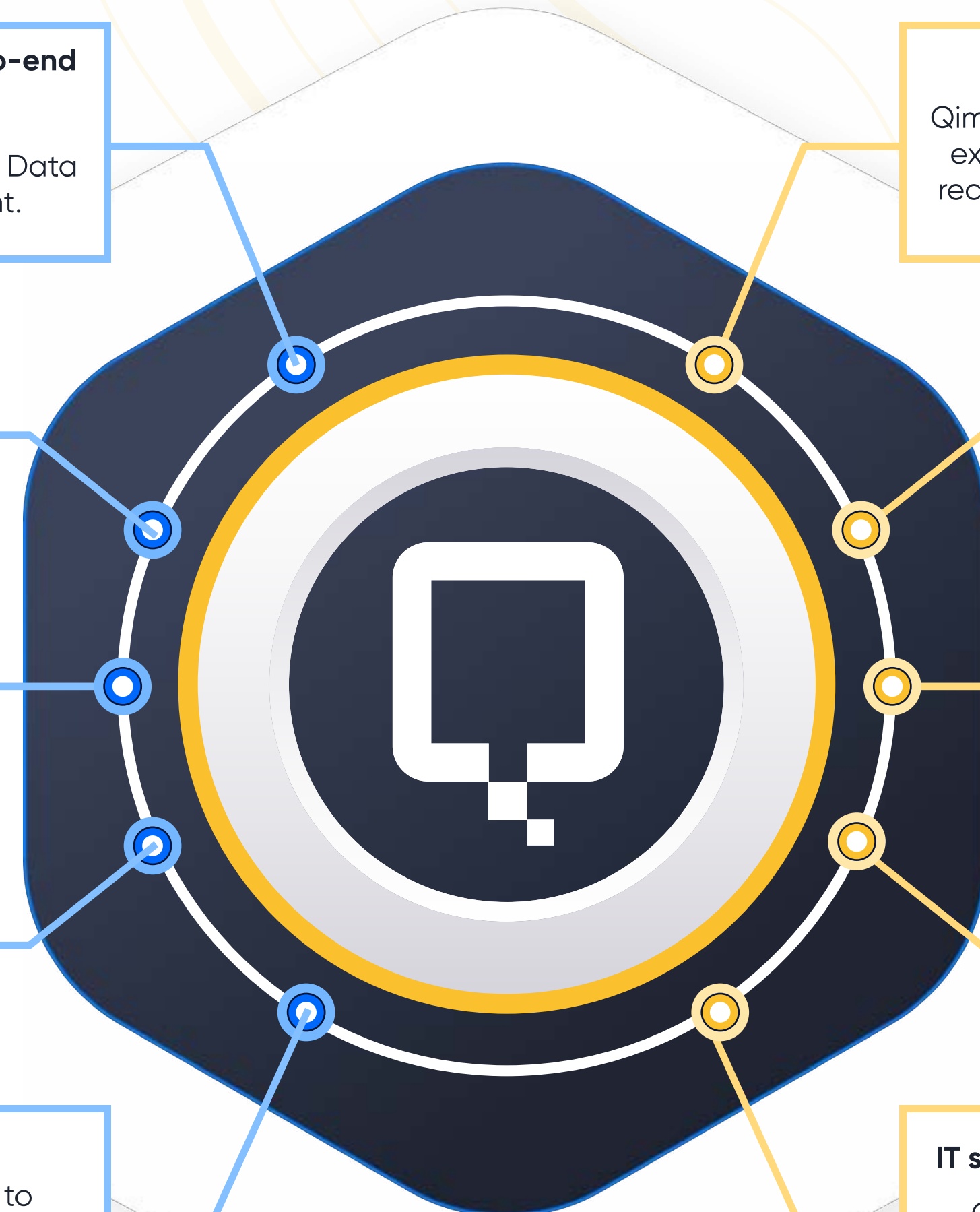

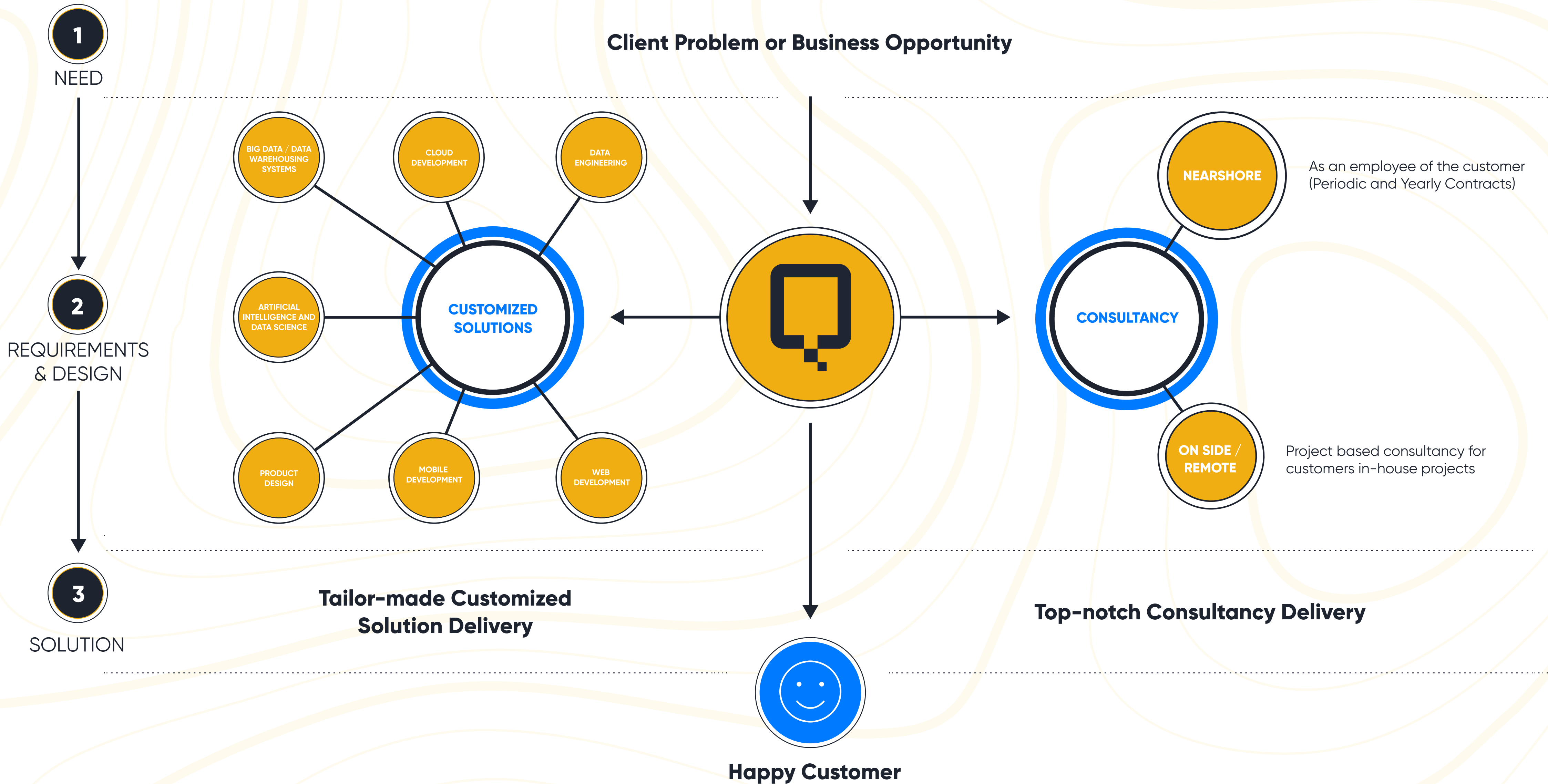



## AWS Data Lake Project

**Data Engineering**

**Industry:** Consulting

**Subject:**

AWS Cloud Data Lake Development;  
Cloud Big Data Engineering

**Description:**

Developing and maintaining data lakes on AWS. Data migration from RDBMS and file sources, loading data into S3, Redshift, and RDS. Designing and developing big data batch solutions using AWS Data Pipeline and AWS Glue and EMR. Developing a massive data warehouse using Redshift and Redshift Spectrum.

[More Information](#)



## Azure Data Lake Project

**Data Engineering**

**Industry:** Consulting

**Subject:**

Azure Cloud Data Lake Development;  
Azure Big Data Engineering

**Description:**

Data lake development on Microsoft Azure. Data migration from RDBMS and file sources, data loading into Azure Blob storage and Azure SQL. Design and development of big data batch solutions using Data Factory and Databricks. Massive data warehouse development using Azure SQL Data Warehouse.

[More Information](#)



## ML / AI Projects

**Recommendation Prediction Model**

**Industry:** E-Commerce

**Subject:**

ML Model implementation for Recommendation Models

**Description:**

User tracking data is used in training ML models for user-profiling, recommendation, and prediction. RNN and CNN models are developed and trained for enrichment of user-profiles. Classification GBM (Gradient Boosting Machine) on extracted and learned features. Workflow implementation for data engineering and continuous model training implementation in Airflow.

[More Information](#)

[More References Projects](#)





## Big Data

## Machine Learning

## Infrastructure

## Datawarehousing & Database

## Front-End Development

## Back-End Development

## Mobile Development

## DevOps

Scala

Java

Python

Apache Hadoop

Apache Spark

PySpark

Kafka

Hive

Databricks

Elasticsearch

Python

(Tensorflow, Keras, PyTorch, Sci-kit learn)

MLFlow

AWS Sagemaker

Azure ML

Spark ML

AWS

Azure

GCP

Cloudera

Docker

Kubernetes

Terraform

AWS Redshift

Azure Synapse

Google BigQuery

Aurora

MySQL

MSSQL

Oracle

MongoDB

Redis

JavaScript

ECS6

HTML

CSS

Jquery

Bootstrap

React

Angular

TypeScript

Next.js

Gatsby

Express.js

SASS

GraphQL

Java

Spring Framework

Scala

Play framework

Python

Django

Node.js

C#

.NET

RestfulAPI

iOS

(SWIFT, Objective-C)

Anroid

(Java, Kotlin)

Flutter

React Native

Xamarin

Gitlab,

Github

Azure DevOps

AWS CodePipeline





Volkswagen



BMW



T-Mobile



Vodafone

SIEMENS

Siemens



RTL



GfK



Allianz



DHL



Deutsche Bahn



Rewe



Otto



Lufthansa

Lufthansa



Henkel



Airplus



LIDL



E-ON



NORD/LB



Commerzbank



UniCredit



Merck

SCHAEFFLER

SCHAEFFLER



Prosieben



IBM

FOSS

FOSS

BERTELSMANN

BERTELSMANN



INFREST



Gloobacap



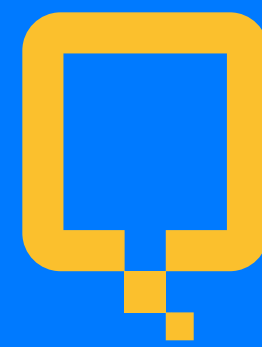

## COLOGNE HQ

📍 Brüsseler Str. 89-93,  
50672

☎ +49 2 21 5796 7940

## HANNOVER

📍 Lavesstraße 80,  
30159 Hannover

☎ +49 2 21 5796 7940

## ISTANBUL

📍 Esentepe Mh. Büyükdere Cd.  
No: 102/56, Maya Akar  
Center Şişli

☎ +90 (212) 216 13 14

## San Diego

📍 9920 Pacific Heights Blvd,  
Ste 350 San Diego, CA  
92626

☎ +1(858) 286-6110

## San Francisco

📍 8910 university.  
Center lane, 92122

☎ +1 (949) 394-1252

✉ [contact@qimia.io](mailto:contact@qimia.io)

 [qimia.io](http://qimia.io)

 [Qimia GmbH](https://www.linkedin.com/company/qimia-gmbh)

 [qimia.io](https://www.instagram.com/qimia.io)

 [Qimia.io](https://www.facebook.com/Qimia.io)